

**SmartFlex™**

With over 100 possible configurations, it's **smart** to get exactly what you need.



+ CONFIGURABLE FOR  
ALMOST ANY APPLICATION

**B+B SMARTWORX**

Powered by

**ADANTECH**

Intelligence at the Network Edge

# SmartFlex™

## GET EXACTLY WHAT YOU NEED

With hundreds of possible configurations, flexible SmartFlex cellular routers can be configured to suit any application.

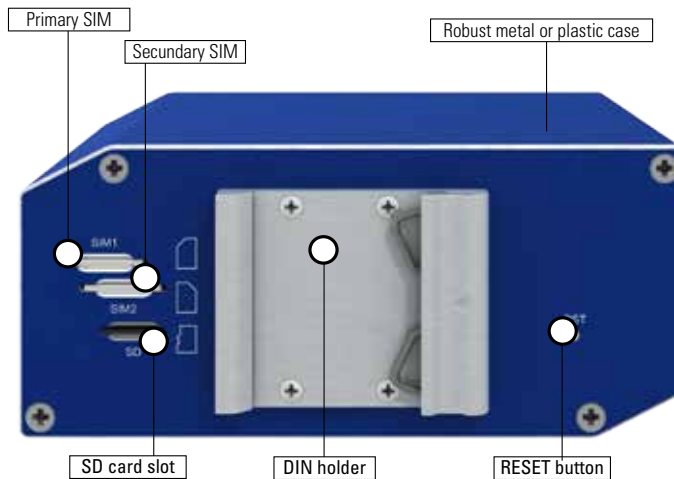
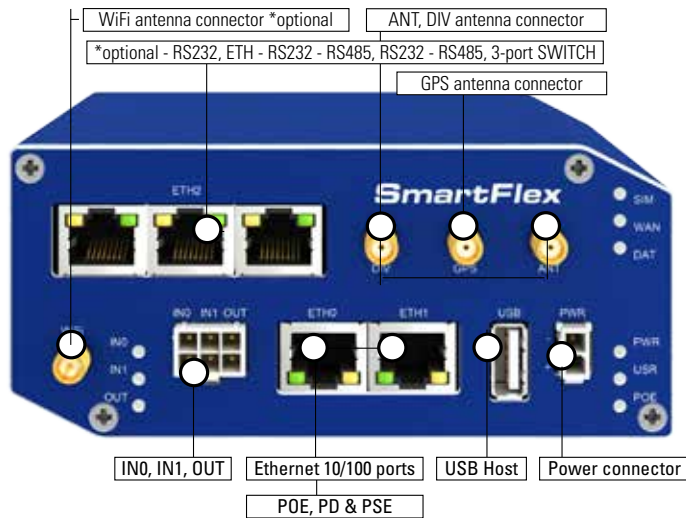

- + Aggregate data from multiple devices: Serial, Ethernet, Wi-Fi, I/O.
- + Standard ports include (2) Ethernet, (1) I/O port, (1) USB port, (2) SIM slots and (1) MicroSD card holder.
- + Optional ports include additional Ethernet ports and RS-232/422/485 serial ports with isolation.
- + The router may have up to (5) Ethernet ports (2 Router, 3 Ethernet Switch).
- + Optional, industrial grade Wi-Fi is available.
- + GPS and GLONASS support.
- + Plastic or Metal Enclosure.
- + PoE models available.
- + Install our User Modules for specific applications or create your own.
- + Switch between cellular carriers at a moment's notice.
- + Connect Modbus equipment.

## Intelligent

- + Download our User Modules for specialized functions. Use the router as an AT Modem Emulator, a Modbus RTU/TCP gateway and more.
- + Create your own Linux scripts for additional special functions.
- + Create multiple software configurations for each router, and switch between them at any time.
- + Upgrade router configuration and firmware from your central server, allowing for simultaneous mass reconfiguration of every router on the network.
- + Use a secure Web interface to configure and manage the SmartFlex™ from remote locations.
- + Low power consumption mode for solar and battery power applications.

## Powerful

- + Full support for LTE
- + 256 MB flash memory, 512 MB RAM and 128kB M-RAM
- + Upload speeds of up to 50 Mbit/s and download speeds of up to 100 Mbit/s - easily handles video applications.





## Safe and Secure

- + Real time data encryption and the creation of VPN tunnels using IPsec, OpenVPN and L2TP.
- + Support for DHCP, NAT, NAT-T, DynDNS, NTP, VRRP, control by SMS and numerous other functions.

## Rugged and Reliable

- + Dual SIM card ports for automatic failover or multiple cellular carrier support.
- + Designed and manufactured for use in tough environmental conditions.
- + Extended operational temperature range from -40 °C to +75 °C.
- + 10-60 VDC operation with transient and reverse polarity voltage protection.
- + Industrial certifications.

## Port Configurations & Options

MODEL NO.	STANDARD CONFIGURATIONS					OPTIONAL PORT CONFIGURATIONS				
	LTE ROUTER	GPS	2X ETHERNET (router port)	USB	I/O	RS232 RS485/422	RS232/485 ETHERNET	3X ETHERNET (switch)	WI-FI	POE
 SR30xxx0xx	✓		✓	✓	✓			✓	✓	✓
 SR30xxx0xx	✓	✓	✓	✓	✓					✓
 SR30xxx1xx	✓	✓	✓	✓	✓			✓	✓	✓
 SR30xxx3xx	✓	✓	✓	✓	✓	✓			✓	✓
 SR30xxx4xx	✓	✓	✓	✓	✓		✓		✓	✓

## + GLOBAL REACH FOR GLOBAL SUPPORT

You build your business and we will build your communication solution. Whether you need standard products or require special designs for specific applications – B+B SmartWorx can help.

**B+B SMARTWORX**

Powered by

**ADVANTECH**

#### **Worldwide Headquarters**

ADVANTECH  
No.1, Alley20, Lane26, Rueiguang Road  
Neihu District, Taipei 11491  
Taiwan, R.O.C  
Phone: 0800-777-111  
[www.advantech.com](http://www.advantech.com)

#### **European Headquarters**

Oranmore, Co. Galway, Ireland  
Phone: +353 91 792444  
Fax: +353 91 792445  
[eSales@advantech-bb.com](mailto:eSales@advantech-bb.com)

#### **Corporate Headquarters**

707 Dayton Road  
Ottawa, IL 61350 USA  
Phone: 1-815-433-5100  
Fax: 1-815-433-5109  
[orders@advantech-bb.com](mailto:orders@advantech-bb.com)  
[www.advantech-bb.com](http://www.advantech-bb.com)

#### **Middle East, UAE, Africa**

[mdeast-frsales@advantech-bb.com](mailto:mdeast-frsales@advantech-bb.com)  
Mobile: +971 50 943 65 62  
AG Silver Tower, JLT, P.O. Box 48777  
Dubai, UAE

#### **Cellular Product Group**

Sokolská 71, 562 04 Ústí nad Orlicí III.  
Czech Republic  
Phone: +420 465 521 020  
Fax: +420 464 647 299  
GSM: +420 603 872 287  
[cellularsales@advantech-bb.com](mailto:cellularsales@advantech-bb.com)

#### **Latin America, Caribbean**

[latamsales@advantech-bb.com](mailto:latamsales@advantech-bb.com)  
Phone: 1-727-797-0300  
Cell: 1-727-480-5920

#### **OEM & Product Modification**

Phone: 815-433-5222  
Fax: 815-433-5104  
Attn: Custom Dept.  
[custom@advantech-bb.com](mailto:custom@advantech-bb.com)  
Custom Quote Request Form:  
<http://advantech-bb.com/custom>